

Step-by-Step
Fold and Cut
Patterns

Valentines-018

Tools and materials: scissors, 4"-6" squared colored paper.
4-sided paper folding instructions:

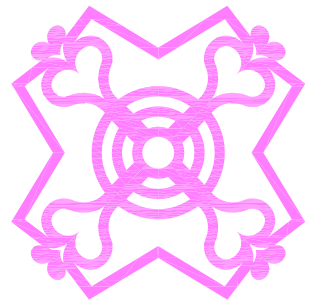
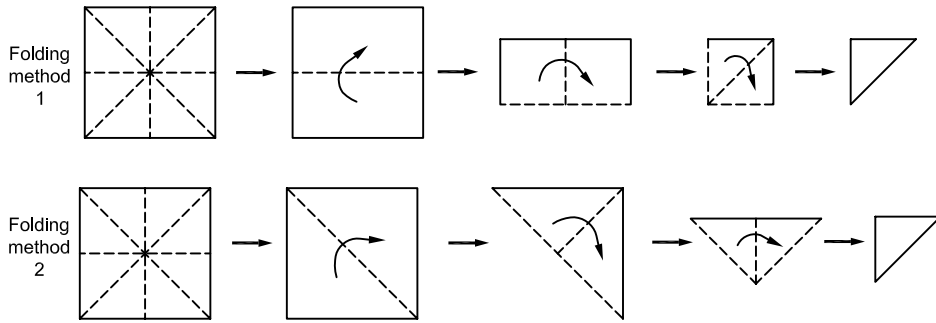

Finished Cutting
Valentines-018

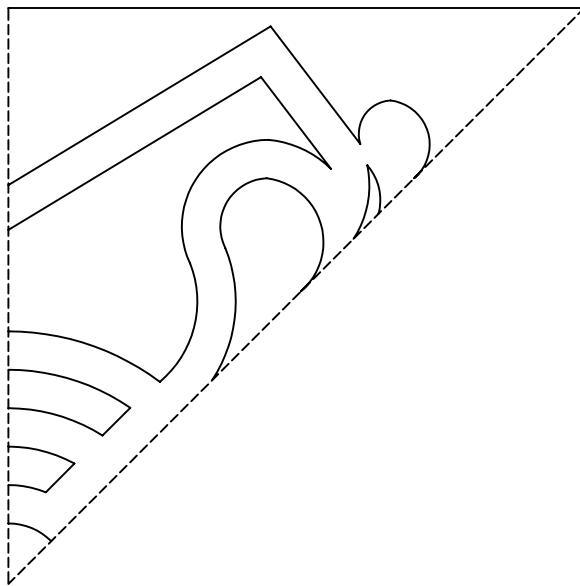

6"x6" square paper pattern

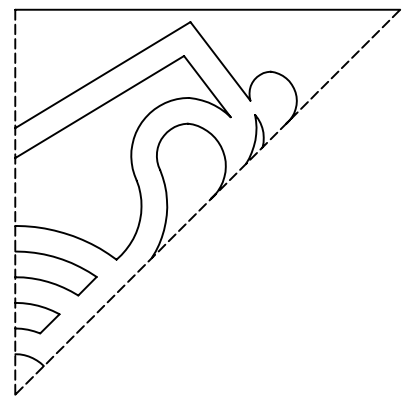

4"x4" square paper pattern

Note: Cut out the hatched parts.