

Step-by-Step
Fold and Cut
Patterns

Valentines-014

Tools and materials: scissors, 4"-6" squared colored paper.
4-sided paper folding instructions:

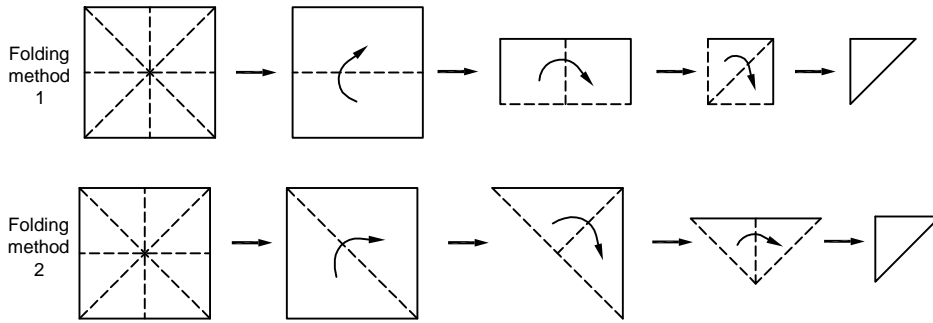

Finished Cutting
Valentines-014

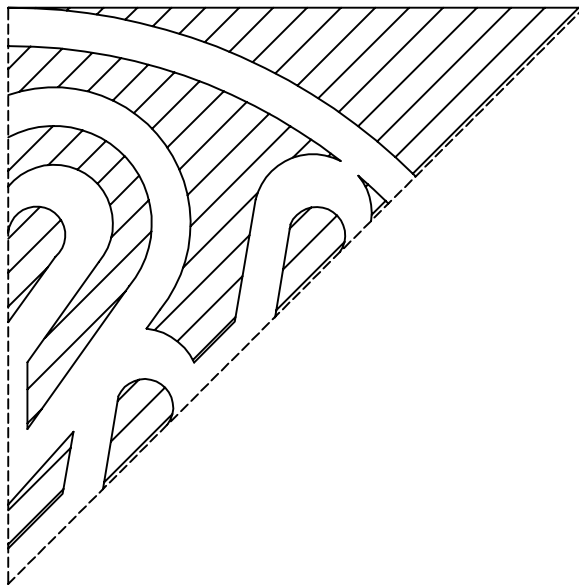

6"x6" square paper pattern

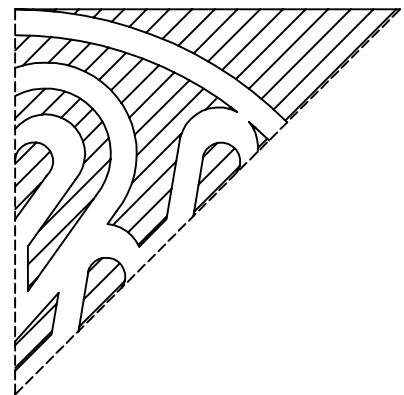

4"x4" square paper pattern

Note: Cut out the hatched parts.