

Step-by-Step  
**Fold and Cut**  
**Patterns**

St-Patricks-Day-014

Tools and materials: scissors, 4"-6" squared colored paper.  
4-sided paper folding instructions:

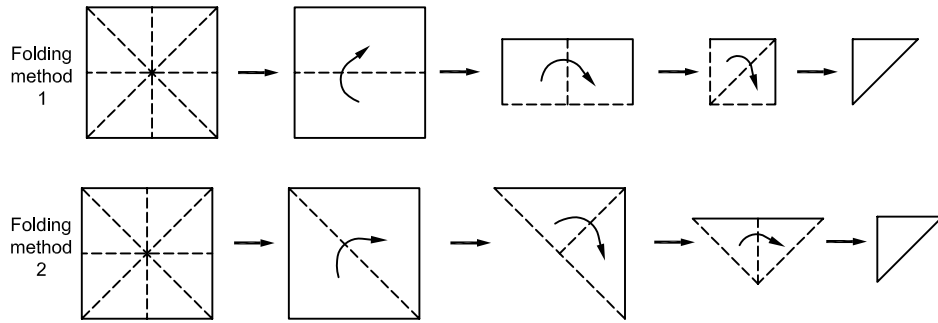

Finished Cutting

St-Patricks-Day-014

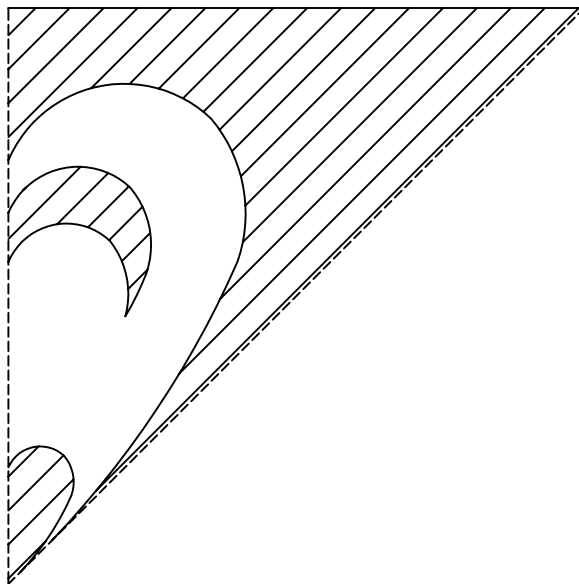

6"x6" square paper pattern

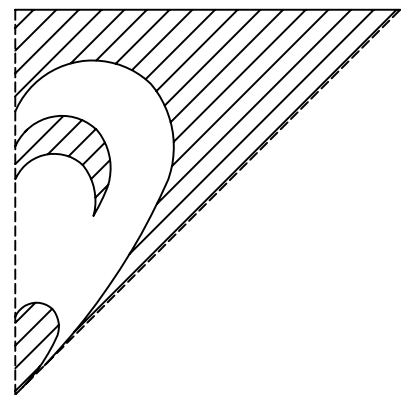

4"x4" square paper pattern

Note: Cut out the hatched parts.