

Step-by-Step  
**Fold and Cut  
Patterns**

Mothers-Day-016

Tools and materials: scissors, 4"-6" squared colored paper.  
4-sided paper folding instructions:

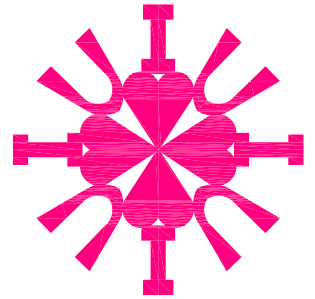
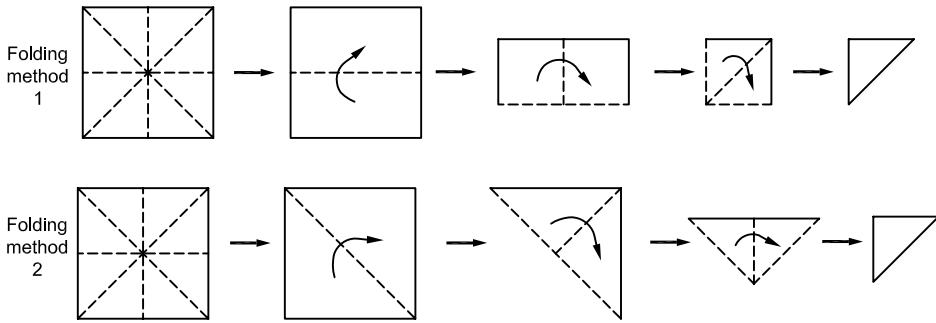

Finished Cutting  
Mothers-Day-016

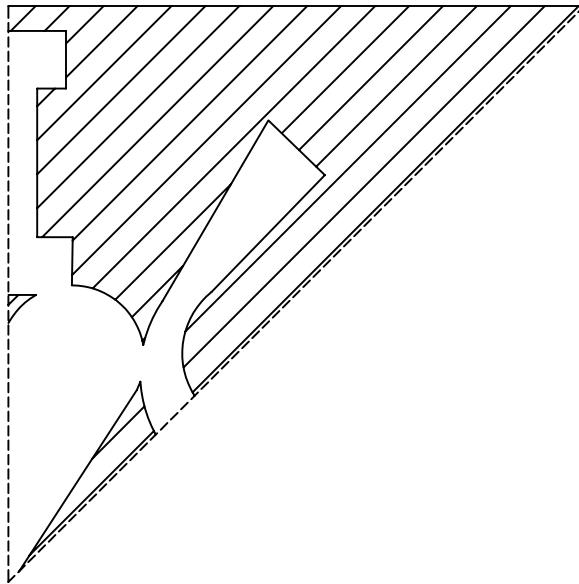

6"x6" square paper pattern

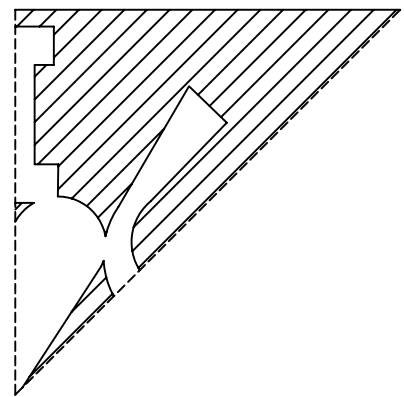

4"x4" square paper pattern

Note: Cut out the hatched parts.