

Step-by-Step
**Fold and Cut
Patterns**

Mothers-Day-008

Tools and materials: scissors, 4"-6" squared colored paper.
4-sided paper folding instructions:

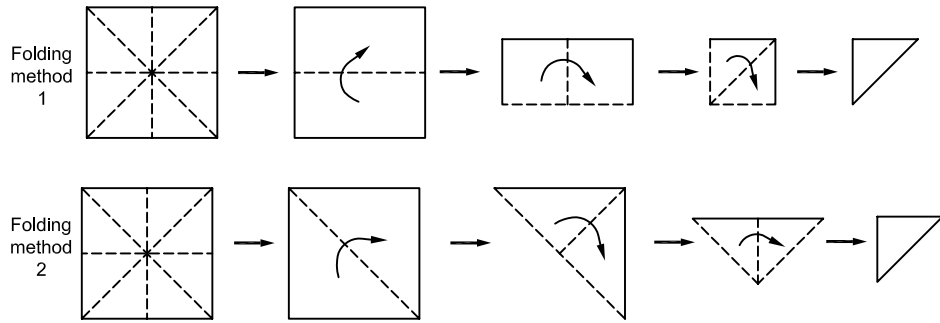

Finished Cutting
Mothers-Day-008

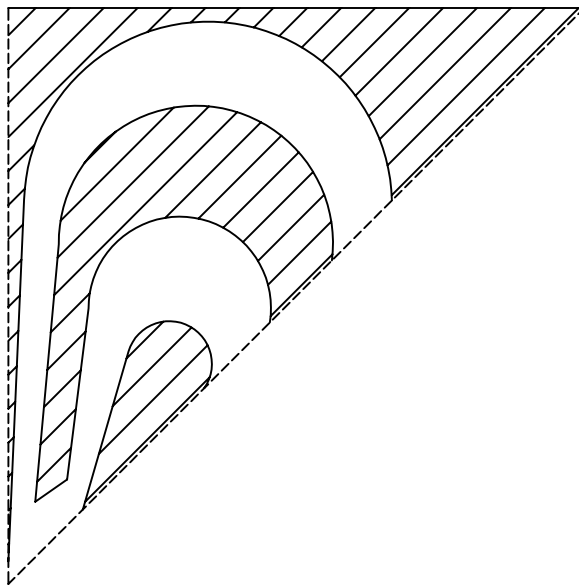

6"x6" square paper pattern

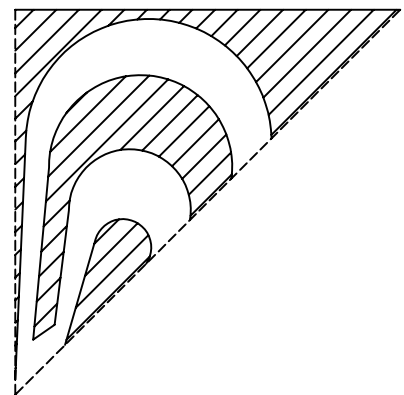

4"x4" square paper pattern

Note: Cut out the hatched parts.